

# Verwerkingshulpmiddelen

- ▶ Mallen, aanslaghulpmiddelen en montagemachines
- ▶▶ Verwerking ladesystemen



## Boormal voor TANDEM



Symboolfoto

- Eenvoudige verwerking van houten laden
- Voorboren van de haakpositie van de ladeprofielen
- Voorboren van de bevestigingsposities voor de TANDEM-koppeling

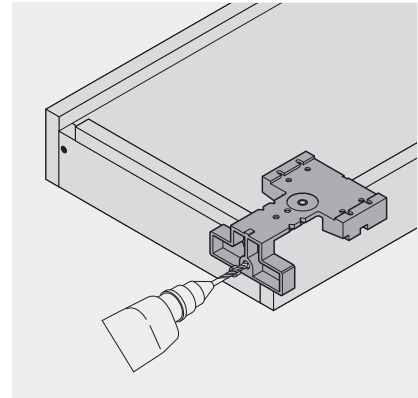

	Art. nr.
Boormal	T65.1000.02

	Art. nr.
Werktuigset	T65.9000

## Aanbrengen van de boring voor de haken

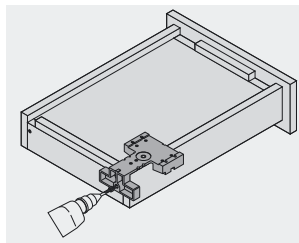

Boren van de haakposities

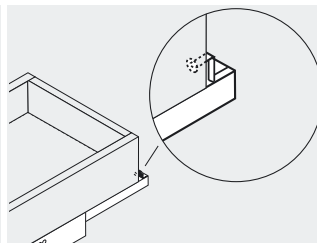

Laden op de haken schuiven

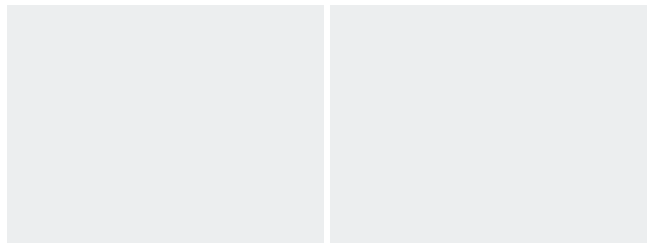

## Aanbrengen van de boring voor de TANDEM-koppeling

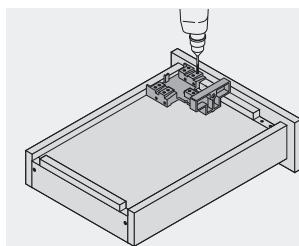

Vorboren van de bevestigingsposities voor de TANDEM-koppeling

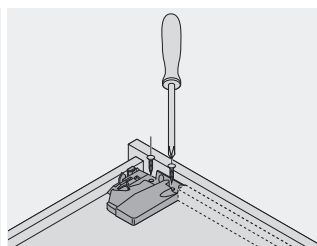

TANDEM-koppeling vastschroeven

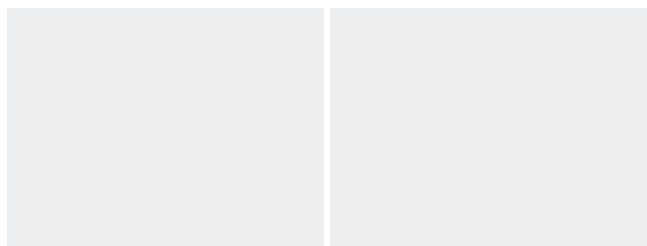

Verwerking